



RGBgenie Touch Panel, 3 Zone RGB and RGBW Controller and Dimmer with Built-In Repeater

Enjoy the convenience of operating your smart lights with a touch panel. The ZB-3007 gives you fingertip zone control of color, dimming, on/off and white color temperature. Features include smooth fading between colors with gentle off dimming and built-in effects. Designed to operate 3 zones and up to 30 lighting devices.

DANGER! - SHOCK HAZARD - RISK OF FIRE - RISK OF BURNS - DANGER!



IT IS IMPORTANT TO READ AND UNDERSTAND THESE INSTRUCTIONS PRIOR TO INSTALLATION. USE A QUALIFIED LICENSED ELECTRICIAN TO PERFORM INSTALLATION. MORE THAN ONE DISCONNECT MAY BE REQUIRED TO DE-ENERGIZE THE SYSTEM. ALWAYS TEST FOR ENERGIZED PARTS PRIOR TO ANY WORK PERFORMED. ALWAYS USE PERSONAL PROTECTIVE EQUIPMENT AND A SAFETY ASSISTANT.

WARNING!

- THERE ARE NO SERVICABLE PARTS IN THIS UNIT.

TOUCH PANEL OPERATION



Color Buttons are used to controll on/off and dimming

- Short press to turn the specific color on or off
- Long press to control brightness up or down of the specific color

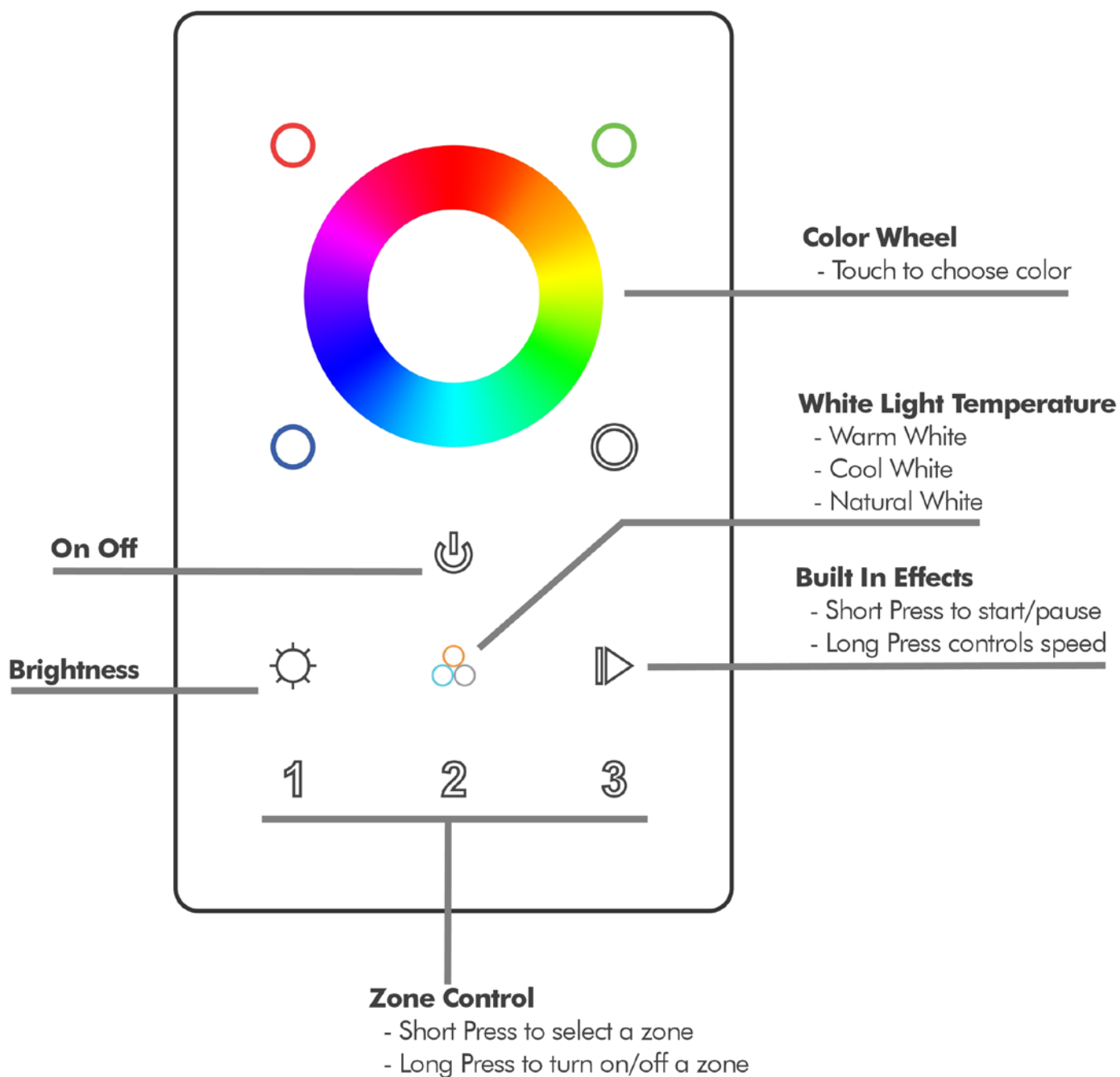

INTRODUCTION

Thank you for choosing RGBgenie as your lighting control provider. This device is compliant with the ZigBee 3.0 standard which is the unification of the HA (Home Automation) and LL (Light Link) profile. This is a Full Function Device that can perform all available operations within the standard and is an always-on device that doubles as a network repeater.

Using wireless signals at 2.4 GHz this product is also suitable for global operation. It has a line of sight transmission range of up to 100 feet. Transmission range is affected by dense objects, such as brick walls, refrigerators, solid doors or the like. For optimal performance, consideration should be given to placement.

This device supports one zone (also known as a group) and can bind up to 30 lighting devices for RGBW control. It is compatible with universal ZigBee gateway products and universal ZigBee lighting devices.

1. Adding to ZigBee Network
2. Checking for Network Inclusion
3. Pairing to ZigBee Lighting Device Through Touch-Link
4. Using the Touch Panel to Reset a Device (ZllResetToFactoryNewRequest)
5. Pairing a Device Through Find and Bind Mode
6. Unpair a Device Through Find and Bind Mode
7. Clear All Paired Lighting Devices of a Group
8. Binding the Touch Panel with a Device in a Coordinator (Hub)
9. Unbinding the Touch Panel with a Device
10. Unbinding the Touch Panel with a Device Controller or Gateway
11. Factory Reset Touch Panel (Remove from a ZigBee Network)
12. Supported ZigBee Clusters
13. Installation Breakdown
14. Dimensions
15. Diagram
16. Products Data

1. ADDING TO A ZIGBEE NETWORK

Before adding to a ZigBee network, please make sure that the Touch Panel does not belong to any prior network. When new, the Touch Panel will be set to inclusion mode by default. If the Touch Panel has been previously added to another ZigBee network it will need to be reset.

From your ZigBee controller select the option to add a new device. Please refer to the instruction manual that came with the controller for adding a device.



From the Touch Panel press and hold the power button until the LED status indicator turns on.



Immediately press the Red Channel button once to enable the Touch Panel to search for nearby networks. The LED indicator will flash once every second.

Network pairing will begin automatically. The Touch Panel will blink 6 times quickly when it has found your network and then turn off. The Touch Panel should now appear in your controller's menu.

IMPORTANT: For the Philips Hue Bridge, no Touch Panel information will appear in the App menu. The only indication of inclusion will come from the Touch Panel so make sure to watch for the 6 quick blinks of the LED indicator.

You can check for inclusion by quickly pressing any button and the LED indicator will blink once. If the indicator does not blink when quickly pressing a button it is still in factory default mode and not included in any network.

If no network is available, or one is not found, the touch panel will timeout after 20 seconds and the indicator LED will turn off without blinking 6 times quickly. Repeat the inclusion operation from the beginning.

2. CHECKING FOR NETWORK INCLUSION

Quickly press any button and the LED indicator should blink once. If the LED indicator does not respond, the Touch Panel is not paired with a network.

3. PAIRING TO LIGHTING WITH TOUCH-LINK

The Touch Panel can pair with lighting devices that support Touch-Link commissioning. Touch-Link is a proximity base mechanism which makes it easy to associate the devices with each other.

Note: This Touch Panel does not need to be added to a ZigBee controller to be bound to another device via Touch-Link. However, the Touch Panel is limited to pairing with only a single device when it is not included in a ZigBee network. When added to a network, the Touch Panel can be paired with up to 30 devices.

Note: For Philips Hue and Amazon Echo Plus, add the Touch Panel and lighting device(s) prior to attempting Touch-Link pairing.

Note: Philips Hue lighting needs to be cycled on to initiate the Touch-Link protocol.

To start, the lighting device will need to be put into the Touch-Link mode. Please consult the device manual for this process.

Bring the lighting device to within 4 inches of the Touch Panel.

1 Click the button of the zone control (1,2 or 3) you wish to assign to the lighting.

 Press and hold down the power button on the Touch Panel until the LED indicator turns on

 Immediately press the Green channel button once to initiate Touch-Link commissioning on the Touch Panel

The LED indicator on the Touch Panel will flash quickly for 3 seconds to indicate the start of the process. The lighting device will flash twice to indicate a successful connection.

4. USING THE TOUCH PANEL TO RESET A DEVICE

Many lighting devices, such as Philips Hue, do not have a physical means to reset them to factory specifications if the controller becomes damaged or is missing. In this case, you can use the Touch Panel to initiate a [ZllResetToFactoryNewRequest] command. The Touch Panel can either be part of the same ZigBee network or not added to any network at all. This command may not function if the Touch Panel is part of a different ZigBee network and may need to be reset. This is only recommended when a device reset is impossible with any other method.

To start, the lighting device will need to be put into the Touch-Link mode. Please consult the device manual for this process.

Bring the lighting device to within 4 inches of the Touch Panel.



Press and hold down the power button on the Touch Panel until the LED indicator turns on



Immediately press the Green channel button twice to send the factory reset command

The LED indicator on the Touch Panel will flash quickly for 3 seconds and then flash 3 times slowly to indicate a successful reset.

5. PAIR A DEVICE THROUGH FIND AND BIND MODE

Finding and Binding a ZigBee device is different than Touch-Link in that it is not proximity based. Typically association between devices with this method is done through a hub or coordinator.

For a lighting device to find and bind a target it needs to scan for nodes in the network. The lighting device will be the initiator node. Please consult the device manual for this process.



Press and hold down the power button on the Touch Panel until the LED indicator turns on.

 Immediately press the Blue channel button once to enable the Touch Panel to find and bind the lighting device, or initiator. The Touch Panel will be the target node.

The binding will be successful within 4 seconds and the LED on the Touch Panel will flash 4 times. If binding fails the LED indicator will flash twice.

6. UNPAIR A DEVICE THROUGH FIND AND BIND MODE

Set the lighting device to find and bind a target in the network. The lighting device will be the initiator node. Please consult the device manual for this process.

 Press and hold down the power button on the Touch Panel until the LED indicator turns on.

 Immediately press the Blue channel button twice to enable the Touch Panel to find and unbind the lighting device, or initiator. The Touch Panel will be the target node.

The unbinding will be successful within 4 seconds and the LED on the Touch Panel will flash 4 times. If unbinding fails the LED indicator will flash twice.

7. CLEAR ALL PAIRED LIGHTING DEVICES OF A GROUP

1 Click the button of the zone control (1,2 or 3) you wish to unbind all devices.

 Press and hold down the power button on the Touch Panel until the LED indicator turns on.

 Immediately press the Blue channel button five times continuously to clear all bound lighting devices within the group.

The LED indicator on the Touch Panel will flash 4 times to indicate successful unbinding.

8. BINDING THE TOUCH PANEL WITH A LIGHTING DEVICE IN A CONTROLLER (HUB)

After the Touch Panel and target device have been added to the same network, click any button to activate the Touch Panel. Then from your ZigBee controller interface choose to bind the device to the Touch Panel as instructed by the manufacturer. The device can now be controlled by the Touch Panel.

Once the binding operation is done, the Touch Panel can still control the device in the event of the coordinator (hub) loss or failure.

Note: Philips Hue and Amazon Echo Plus do not support this function, please use Touch-Link for pairing.

9. UNBINDING THE TOUCH PANEL WITH A DEVICE IN A CONTROLLER (HUB)

To unbind the Touch Panel and lighting device, first, click any button to activate the Touch Panel. Then from your ZigBee controller interface, choose to unbind the device from the Touch Panel as instructed by the manufacturer.

10. FACTORY RESET THE TOUCH PANEL

If the Touch Panel has been added to a ZigBee controller (hub), it is always best to remove the device from within the controller interface. If that is not possible or is unsuccessful, the Touch Panel can be manually reset.

Note: All stored zones and devices will be lost when the Touch Panel is reset. The Touch Panel will be restored to the factory default settings.



Press and hold down the power button on the Touch Panel until the LED indicator turns on.



Immediately and quickly press the power button 5 times. The LED indicator will flash three times quickly to indicate successful removal from the network and is now reset to factory default.

11. SUPPORTED ZIGBEE CLUSTERS

Input Clusters:

- Basic
- Power configuration
- Identify
- Diagnostics

Output Clusters:

- Identify
- Scene
- Color Control
- On/off
- Level Control
- OTA

12. INSTALLATION BREAKDOWN

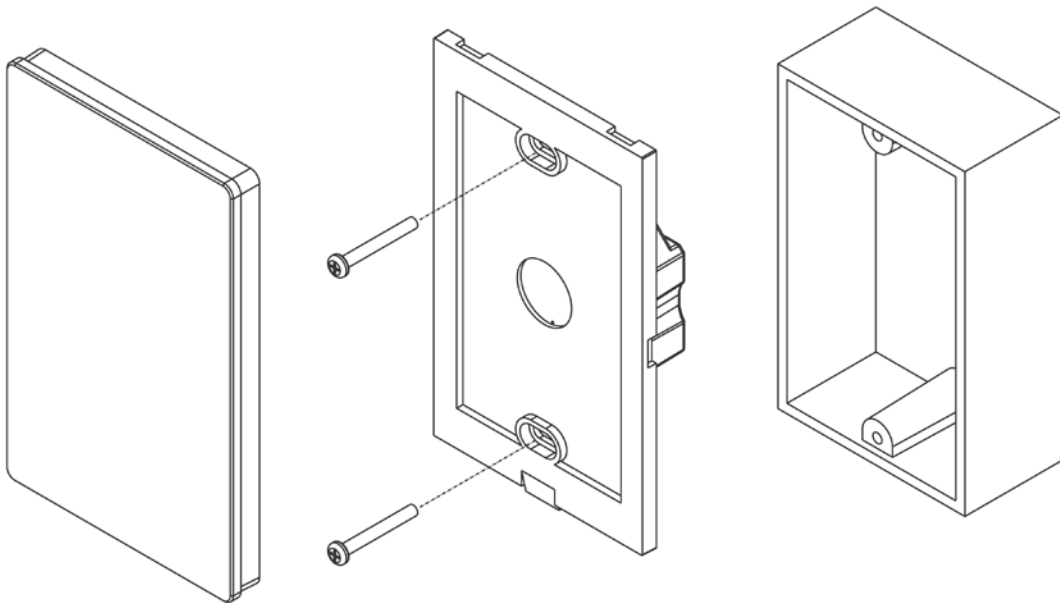

13. DIMENSIONS

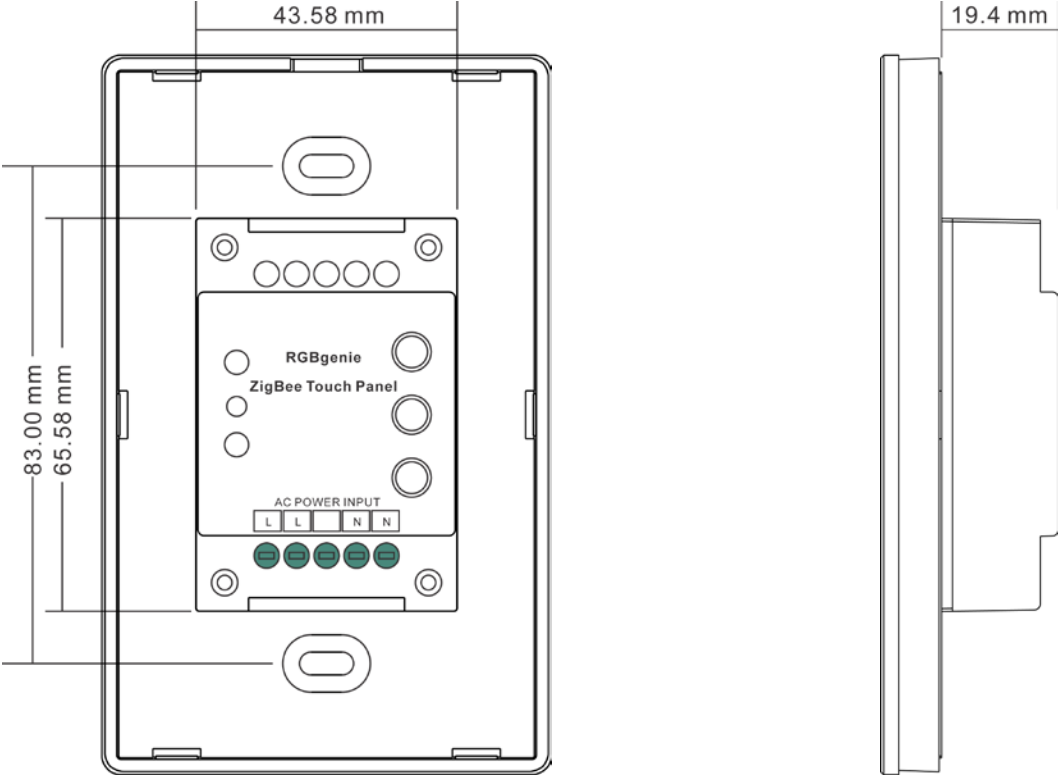

14. DIAGRAM

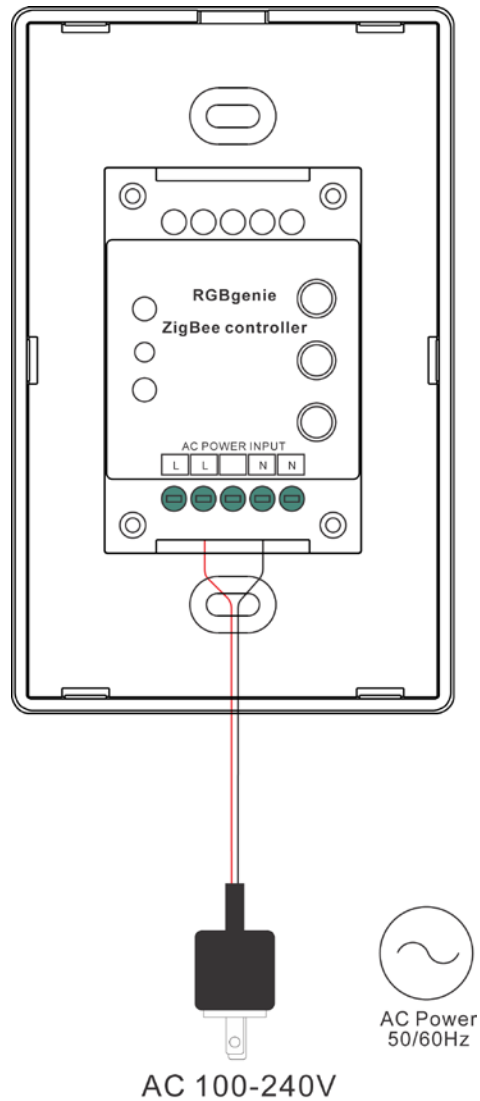

15. PRODUCT DATA

| | | | |
|---------------------|------------|-----------------------|---------------|
| Operation Frequency | 2.4GHz | Operating temperature | 32-85°F |
| Power Supply | 100-240Vac | Relative humidity | 8% to 80% |
| Transmission Range | 100 Feet | Dimming Range | 1%-100% |
| Protection Type | IP20 | Dimensions | 120x75x29.1mm |